

KABELTRAX

A member of the TSUBAKI GROUP



Cable Routing and Management Systems

INNOVATION

Wire Track Assemblies

QUALITY

Main Body Harness

AUTOMATION

Flexible Installation Tapes

Swing Doors

Sliding Doors

PROTECTION

ORGANIZE

INNOVATION

Steering Columns

Wire Bundles

Retractable Tops

Automated Assembly

ISO-9001

Wire Harnesses

ISO/TS-16949 Certified

Design and Expediting Services

INNOVATION

On-time Delivery

QUALITY

Global Inventory Management

AUTOMATION

会社紹介



KabelTrax 世界的な

我々は、あらゆる困難な用途における電線ハーネスの安全な処理に関して、多くの経験があり、最適なデザインを追及します。

- スライドドア
- スイングドア
- サンルーフの開閉
- 座席
- 折りたたみ式の座席
- ステアリング・コラム
- 頭上のディスプレイ

KabelTraxは、自動車業界で使用される電線ハーネス処理の最大メーカーです。我々のシステムは、正確に動作することにより、送電システムや精密な回路を安全に保護します。世界中での数多くの経験により、我々は小さなスペースで精密な部品を安全に作動させるための電線ハーネスを提案いたします。

我々の数多くの商品や技術により、困難な要求に対しても柔軟に対応し、自信を持って解決策を提案いたします。

各製造プロセスの自動化や品質管理体制により、100%品質不良ゼロと100%納期を達成しました。

生産拠点のグローバル化により、輸送コスト、為替リスクや言葉の障壁によるリスクを最小限にし、タイムリーな対応を実現しました。

我々の優れた製品のデザイン、技術蓄積や製品技術により、適正で競争力のある価格を実現しました。

KabelTraxは、今までの技術や既成概念にとらわれることなく、顧客の個別要求に対して革新的な解決策を提案し続けます。

UNTERNEHMEN EINFÜHRUNG

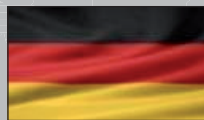

KabelTrax Weltweit

Entdecken Sie die wahre Design-Freiheit – Vertrauen Sie KabelTrax. Als Experten für sichere Leitungsführung und Steckverbindungen selbst bei anspruchsvollen Anwendungen.

- Schiebetüren
- Schwenktüren
- Einfahrbare Hardtops
- Sitze und Umklappbare Sitze
- Lenksäulen
- Overhead Displays

und vieles mehr...

Vertrauen Sie auf unsere Designerfahrung und wählen aus einer großen Werkstoffpalette für einfache und anspruchsvolle Anwendungen das für Sie beste Produkte.

Unsere hochautomatisierten Prozesse sowie Qualitätssicherung gewährleisten Produkte mit Null-Fehlerrate (Zero Defects), die regelmäßig und stets pünktlich produziert und geliefert werden.

Wir produzieren weltweit mit kurzen Reaktionszeiten und liefern dort wo unsere Kunden die Ware brauchen.

Durch den Aufbau und die Nutzung von bewährtem Know-How und die Entwicklung neuer Ideen senken wir Ihre Projektkosten nutzen jedoch hierbei alle Möglichkeiten von Material, Verfahren oder Design bis hin zum Produktionsstandort

– wir liefern bahnbrechende und optimal auf die einzigartigen Bedürfnisse jedes einzelnen Kunden angepasste Lösungen.

COMPANY INTRODUCTION

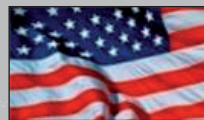

KabelTrax Worldwide

Discover real design freedom - have confidence in safely managing wires and wire-harnesses in all kinds of challenging applications.

- Sliding doors
- Swing doors
- Retractable hardtops
- Seats
- Fold down seats
- Steering columns
- Overhead displays

and many more...

KabelTrax is the largest supplier of automotive wire management and routing systems that safely guide and protect sensitive circuits within defined operating envelopes. With millions of systems sold around the world, our systems are designed-to-suit solutions for wire harness applications that must operate safely around sensitive components or in constrained spaces.

Our wide range of materials gives us the design flexibility needed to confidently solve the most challenging applications.

Through the extensive use of automated manufacturing processes and quality systems we are a zero defect manufacturer that has consistently supplied 100% quality components 100% of the time – on time.

Our strategically located global flexible manufacturing operations enable us to minimize logistic costs, FOREX risk, response times and errors due to language barriers.

Our proven product design integration expertise and product technology result in viable cost effective solutions.

KabelTrax is not limited by materials, designs, processes or locations – we improve the operating efficiency of wire harnesses with our innovative routing and management solutions that perfectly suit our customer's unique requirements.

AZIENDA INTRODUZIONE

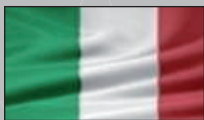

KabelTrax In tutto il mondo

Scoprite nella progettazione la vera libertà – la certezza di una guida affidabile dei cavi in tutte le applicazioni impegnative

- Portiere scorrevoli
- Portiere basculanti
- Tettucci apribili
- Sedili
- Sedili ribaltabili
- Meccanismi di sterzo
- Displays aerei

E molto di più ...

KabelTrax è di gran lunga il più grande fornitore di sistemi di guida dei cavi nelle applicazioni automotive. Sono molti milioni i nostri sistemi applicati a diversi modelli di veicoli circolanti in tutto il mondo, soluzioni progettate su misura, che devono operare in sicurezza attorno a componenti sensibili, in spazi contenuti, in ambienti diversificati, con il 100% di affidabilità.

La nostra ampia gamma di materiali offre la flessibilità di progettazione necessaria per risolvere con competenza tutte le applicazioni. Le soluzioni individuali costituiscono per KabelTrax lo standard.

Grazie all'uso estensivo di processi di produzione automatizzati e sistemi specifici di qualità noi siamo un fornitore a zero difetti, che ha costantemente fornito il 100% di qualità con il 100% della puntualità

Tramite le operazioni strategiche di produzione globale e flessibile siamo in grado di minimizzare i costi di logistica, il rischio FOREX, i tempi di risposta e gli errori dovuti alle barriere linguistiche.

L'esperienza e la tecnologia, il design dei nostri prodotti e l'integrazione, permettono soluzioni dai costi efficaci. Distinti saluti, a Vostra completa disposizione.

SOCIÉTÉ INTRODUCTION



KabelTrax Mondiale

Découvrez la vraie liberté du design et profitez du savoir-faire de KabelTrax pour protéger votre gestion de câblage (cables, fixations et connecteurs) dans toutes les applications, même les plus exigeantes.

- Portes coulissantes
- Portes pivotantes (swing doors)
- Toit rigide rétractable
- Sièges
- Sièges repliables
- Colonnes de direction

et encore plus

Dans l'industrie automobile, KabelTrax est le plus grand fournisseur pour les systèmes de portecâbles conçus à protéger en toute sécurité vos circuits d'alimentation particulièrement sensibles dans leurs enveloppes de mouvement permanent. Jusqu' à ce jour, KabelTrax a vendu des millions de systèmes chaîne portecâbles sur les marchés mondiaux. Nos systèmes sont des fabrications spéciales, développées sur mesure pour des applications de câblage en assurant une opération fiable autour des composants fragiles ou dans des espaces étroits. Notre grande palette de matériaux nous permet de vous offrir une flexibilité de design et de vous fournir en toute confiance des solutions pour les applications les plus exigeantes.

L'utilisation des processus de production hautement automatisés et couplés à un système d'assurance qualité, permet à KabelTrax d' être un fournisseur à zéro-défaut qui a constamment livré des produits de la plus haute qualité tout le temps – en juste-à-temps ("just-in-time").

Notre compétence démontrée dans l'intégration de conception produit et d'industrialisation vous assure des solutions à coûts optimisés.

KabelTrax n' est pas restreint par les matériaux, les designs, les processus ou l'emplacement de ses usines – vous pouvez profiter de notre savoir-faire et de nos solutions révolutionnaires conçues aux souhaits uniques de nos clients.

公司简介



全球的 KabelTrax

探索真正的设计自由- 在各种挑战性应用场合都对线缆和线束的安全管理充满信心。

- 滑动门
- 旋转门
- 伸缩车顶
- 座椅
- 折叠式座椅
- 转向柱
- 架空显示屏

更多应用...

KabelTrax是全球最大的汽车线缆管理和布线系统的服务商, 提供限定运行结构中安全导向和保护敏感电路系统的服务。我们销往全球的数百万套系统都满足了客户的个性化需求, 确保线束在敏感元件或规定的空间安全运行。

我们众多的产品可供选择, 提高了设计的灵活性, 可解决最苛刻的应用难题。

通过坚持自动化生产流程控制和严格的质量管理系统, 我们成为了一个零缺陷的供应商, 一直100%准时提供100%优质产品。我们的全球战略性柔性制造网络将物流成本和外汇风险最小化, 缩短了响应时间, 避免了语言障碍导致的失误。

我们的各套经济型方案来源于我们已证实的产品设计集成技能和成熟的产品技术。

KabelTrax通过综合材料、设计、工艺和网络等优势因素, 提供创新性的布线管理方案, 提高了线束的运行效率, 完全满足了客户独特的需求。

Cable & Wire Routing and

■ Design



■ Testing



■ Production



■ Assembly



■ Displays

- Steering columns
- Displays
- Dashboards



- Seat positioning systems
- Seat height adjustment
- Heating and ventilation
- Seat power and electronics



- Sliding doors
- Suspension doors
- Swinging doors

kabeltrax.com

Management Solutions

■ Multifunction tables



■ Rear hatches and doors
■ Retractable service ramps



■ Door Systems



■ Seating Systems



■ Retractable Roofs



■ Interior Accessories



kabeltrax.com

Wire and Cable Management

■ Sliding Doors



■ Rear Doors



■ Swinging Doors



■ Adjustable Seats



WIRE HARNESES IN MOTION

Our dynamic wire management solutions offer engineers mass-production proven and globally competitive solutions to their most complex moving wire harness challenges.

Our system assemblies substantially increase the operating efficiency and longevity of wires, by reducing circuit failures while bringing uninterrupted power and control to moving mechanisms. Our innovative wire management solutions are perfectly suited to each of our customer's unique requirements.

Our impressive record of innovative solutions to manage wire harnesses moving in single or multi-axis motion spans the world. With millions of automotive systems in operation across the globe, we are the world leader.



kabeltrax.com

Systems for Doors and Seats

PRODUCT SOLUTIONS

KabelTrax designed and built-to-suit products offer engineers proven and globally competitive solutions to their most complex moving wire harness challenges.

Wire Track (WT) Assemblies

Confidently bring uninterrupted power and control to moving mechanisms by safely guiding and protecting all circuits.

Cassette (CAS) Turn-Key Systems

Turn-key CAS systems utilize proven WT technology to solve challenging installation requirements. These easy-to-install systems keep circuits hidden from view, protected and aligned during operation, substantially increasing wire harness longevity.

Slim-Line (SL) Solutions

SL systems insure proper guidance, alignment and support to the WT when available space is at a premium.

■ Wire Track Assemblies



■ Cassette Turn-Key Systems



■ Plug-n-Play Cassette Systems



■ Slim-Line Systems



kabeltrax.com

Wire routing and management solutions

■ Multifunction Seats



APPLICATION EXAMPLES

We will design a specific solution to suit your needs where standard solutions from a catalog simply will not. Our wide range of designs, materials and expertise ensures that our solutions satisfy our customers' unique requirements for form, fit, performance and cost.

■ Service Ramps



Solutions for protecting circuits in:

- sliding doors
- swing doors
- seats
- retractable hardtops
- truck tilt cabs
- hybrid and electric vehicles
- automated banking
- automated vending
- automated gaming
- automatic doors and screens
- and many more!



■ Retractable Tops



■ Steering Columns



■ Sliding Doors



■ AV Accessories



Solutions around the entire vehicle

OPERATING EXAMPLES

Decades of experience in product design, development and applied technology ensure that we have the expertise and product solutions to tackle our global customers' most challenging applications.

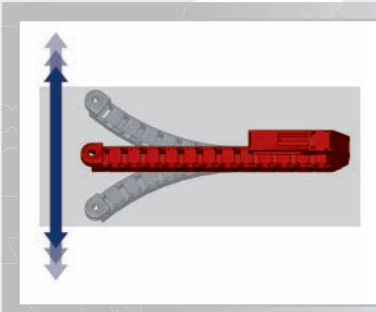

Lateral
Ideal when dual-axis movement such as forward and back as well as in and out is required.

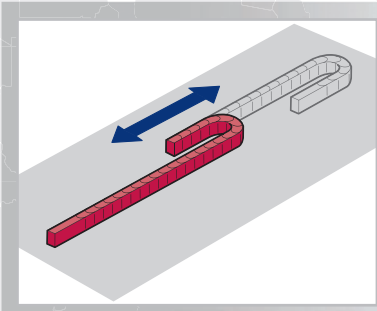

Horizontal
Ideal when operating height is at a premium.

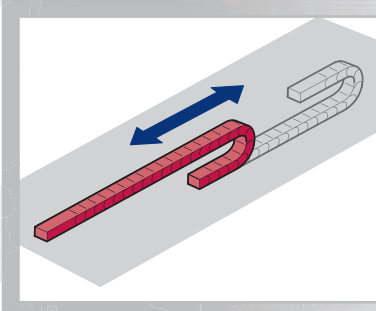

Vertical
Ideal when operating width (depth) is at a premium.

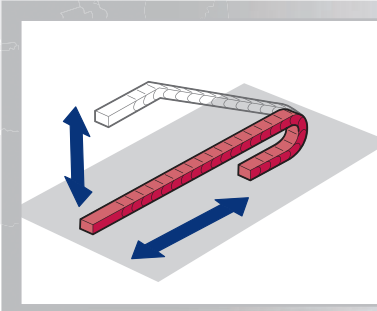

Horizontal/Vertical
Ideal when the required movement is in 2 axes.

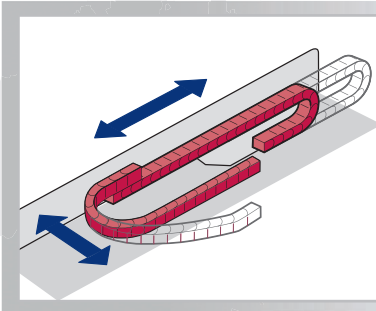

Combined
2 systems. Ideal when multi-axis operation is required.

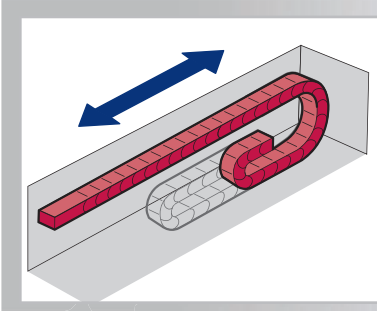

Rolled
Ideal when the fixed point is off center and height is restricted.

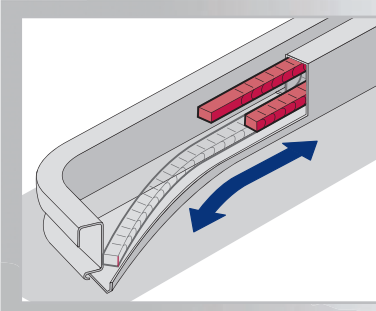

Cassette
Ideal all-in-one system when installation steps must be reduced and simplified.

FIT - Wire Routing and

Under seats



Underbodies



Dashboards



Sidewalls



FIT solves common wire routing problems...

Our wire (harness) routing solutions offer engineers highly functional, truly innovative and simple solutions to their most complex wire routing challenges.

Our Flexible Installation Tapes or **FIT** will substantially decrease wire harness component count, reduce difficulties of packaging harnesses into vehicle architecture, lower installation time while increasing the longevity of wire harnesses by reducing circuit failures. Our innovative wire routing solutions are perfectly adapted to each of our customer's unique needs.

Safely route wires in, around, over and through difficult spaces as well as evade potentially damaging edges using our innovative solutions. Avoid using numerous other methods to route, secure and align wires with one breakthrough solution that will efficiently fit your technical, installation and commercial needs.

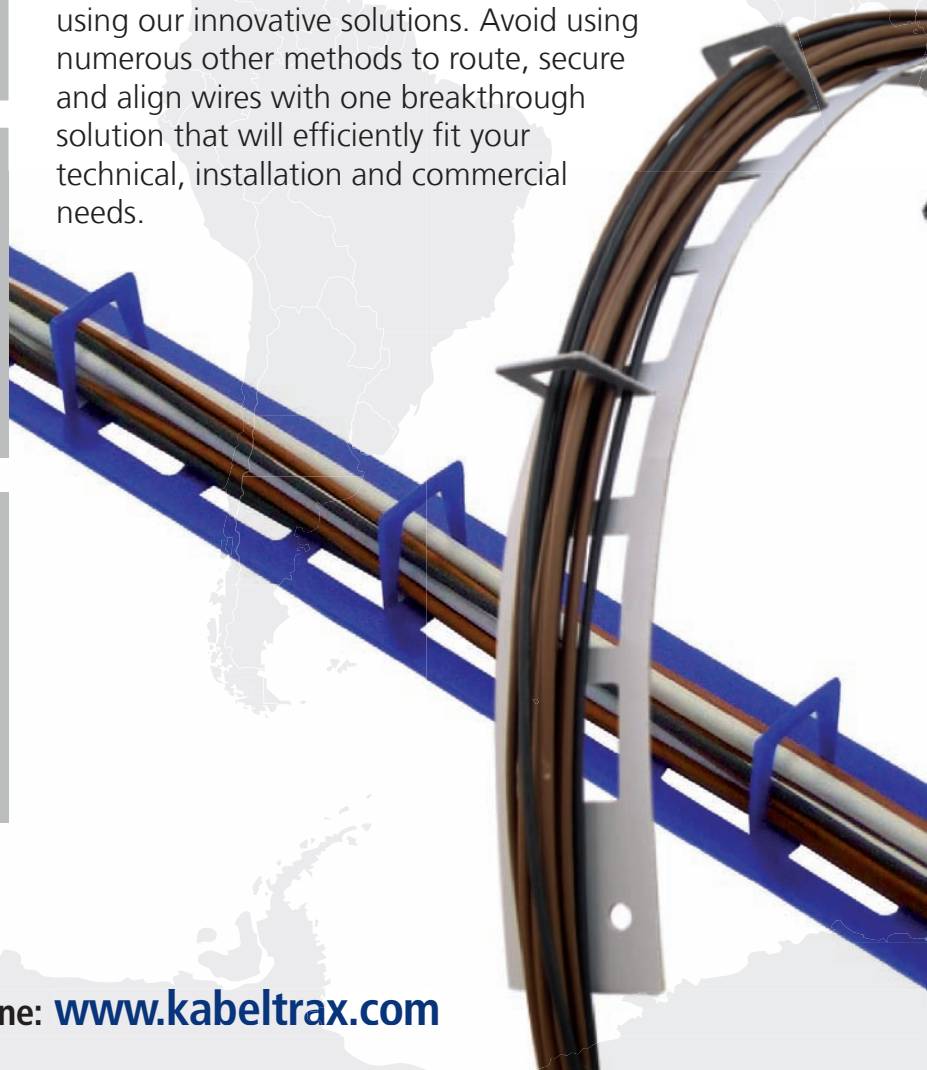

kabeltrax.com

Guidance Systems

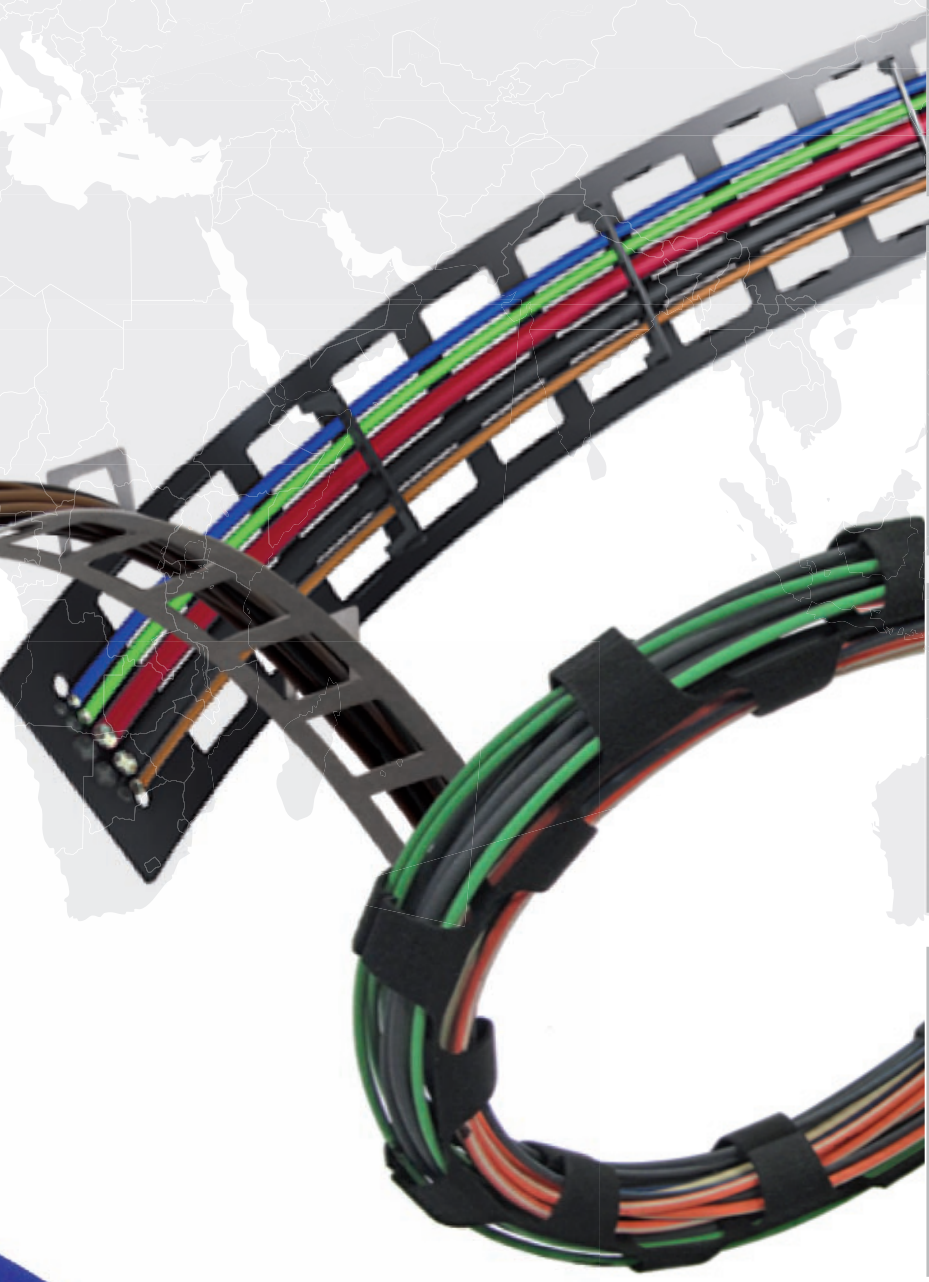

■ Stamped or Cut



■ Molded



■ Press-Through

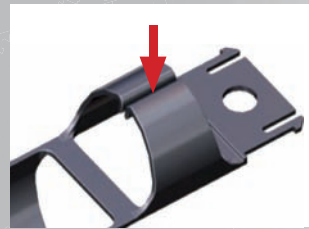

■ Pull-Through

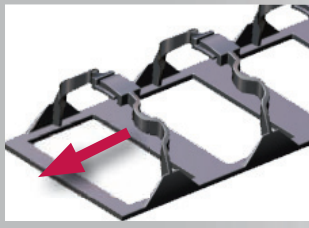

kabeltrax.com



Innovation = Opti



■ Pop-Up

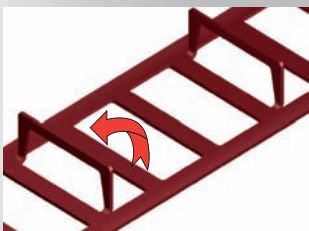

■ Press-In



■ Multi-Cavity

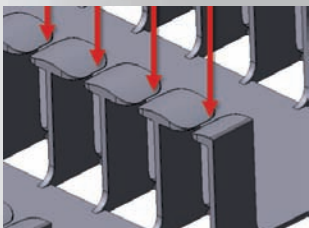

■ 2-Piece



FIT Design Flexibility

As available space decreases and circuit counts increase the room for wires to safely run their path continues to shrink.

Our innovative low cost wire routing systems help customer's address these challenges by increasing design flexibility whilst simplifying assembly and installation.

Our **FIT** solutions:

- are lightweight
- are available in durable material and color options
- are formed to fit unique spaces and shapes
- are flexible to align with fastening holes in customer applications
- are designed to use customer required fastening hardware
- allow easy shipment, handling and installation
- can be modular for standardization

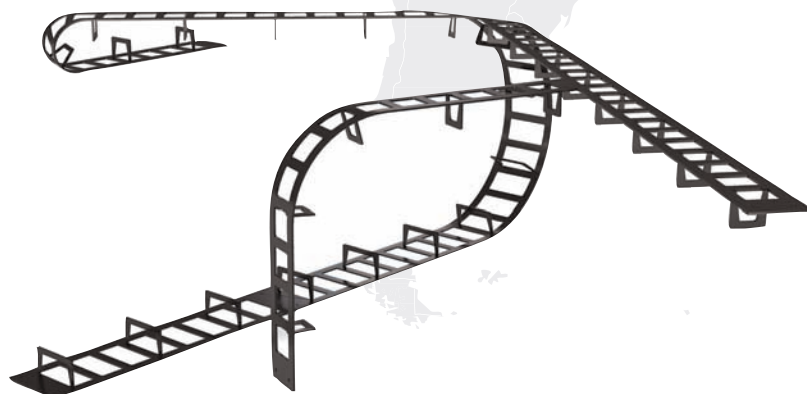

- with **FIT**, even the complex wire routing harnesses can be easily designed and cost effectively produced

ons = Design Flexibility

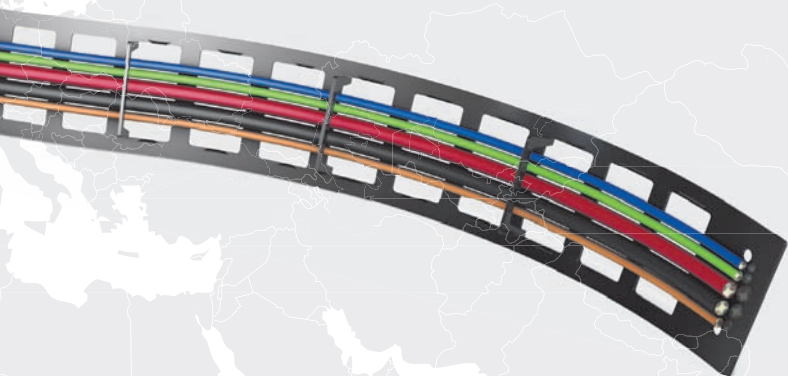

FIT efficiently reduces the need to use numerous products from several suppliers to manage, secure and hold-in-place a bundle of wires.

Our solutions are specifically designed to fit the customers available space and route greatly simplifying assembly time, installation and serviceability.

FIT improves aesthetics and function while reducing or eliminating the need for:

- tape
- wire-ties
- split conduits
- spiral wraps
- shrink tubing
- braided composite tubes
- wire trays



■ replace wire ties



■ replace spiral wraps



■ replace braided tubes



■ replace tapes & conduits

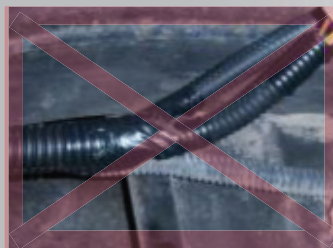

Our Total Quality Promise

The core of our Total Quality Promise (TQP) ties customer requirements, product design and production processes together.

We are continuously evaluating the form, fit, function and ultimate performance of our products by utilizing the latest computer aided design and product simulation methods whilst constantly optimizing our automated production processes to ensure repeatable deliverable total quality as well as heightened customer confidence and value.

At KabelTrax, our difference is built on a record of 100% on-time deliveries, in-time support and quality product received every-time.

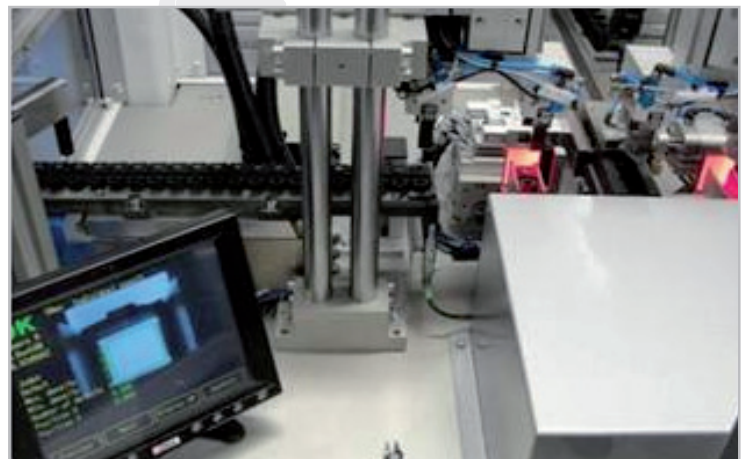
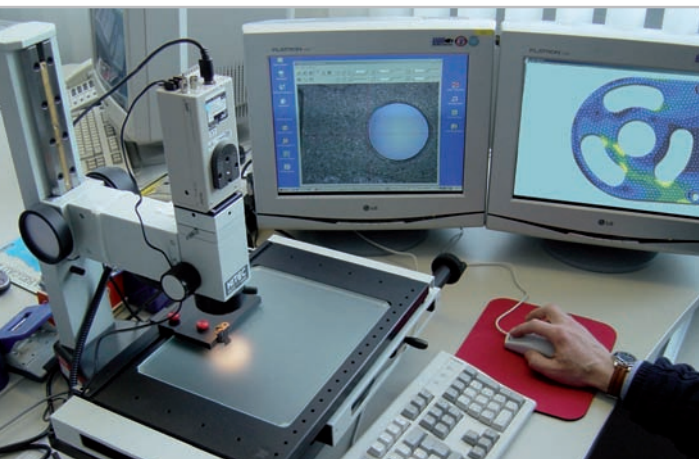
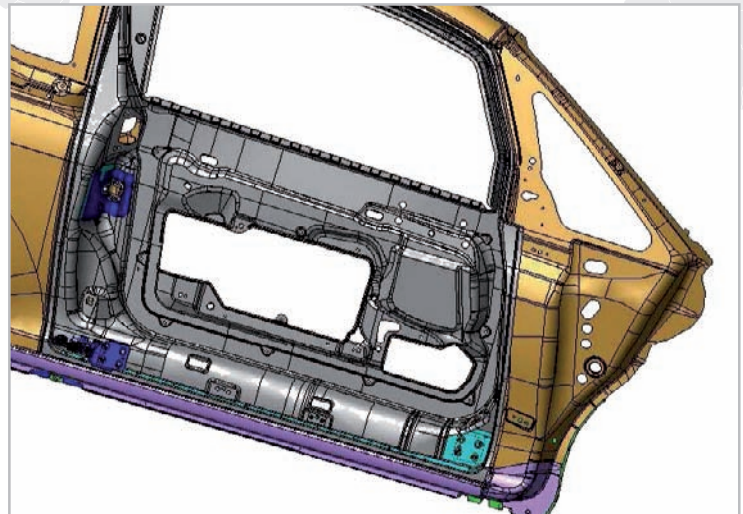

The KabelTrax Difference

Why choose KabelTrax?

Our expertise, service, flexibility, quality and environmental responsibility deliver the VALUE customers demand. These principles are key to our culture and built into every product we sell.

Delivering on these principles everyday gives our customers the confidence necessary to make us a world leader!



The TSUBAKI GROUP – global service and support

“It is our principal objective to meet the requirements and expectations of our customers at all times.”

Principal production facilities in Asia, Europe, North America



■ Asia - Kyotanabe, Japan



■ Europe - Wenden, Germany



■ America - Milwaukee, USA

KABELTRAX

A member of the TSUBAKI GROUP

PRINCIPAL MANUFACTURING FACILITIES

- **Europe** - Wenden-Gerlingen, Germany
- **Asia** - Kyotanabe, Japan
- **America** - Milwaukee, WI, USA



EUROPE

KabelTrax Europe GmbH
Daimlerstraße 2
D-57482 Wenden-Gerlingen
Germany

PH: +49-2762/4003-0
FX: +49-2762/4003-220
E-mail: info@kabeltrax.de

ASIA

KabelTrax LLC
TSUBAKIMOTO CHAIN CO
1-1-3 Kannabidai
Kyotanabe
Kyoto 610-0380
Japan

PH: +81-774-64-5023
FX: +81-774-64-5212
E-mail: ktxasia@kabeltrax.com

NORTH AMERICA

KabelTrax LLC
7100A W. Marcia Road
Milwaukee, WI, 53223-3363
U.S.A

PH: (414) 354-1994
ext.120
FX: (414) 354-1900
E-mail: info@kabeltrax.com

TO LEARN MORE, PLEASE VISIT US ONLINE AT: **WWW.KABELTRAX.COM**